

# GV6-150 series

150W Waterproof Constant Voltage LED Driver



## Features:

- European AC input voltage: 176-264VAC
- Constant voltage design
- Built-in active PFC function (PF > 0.97)
- Protections: Short Circuit / Over Current / Over Temperature / Input Under Voltage
- Cooling by free air convection
- Surge immunity: Differential Mode - 6kV, Common Mode - 10kV
- IP67 design for indoor and outdoor applications
- Suitable for dry/damp/wet locations

## Application:

- Landscape Lighting



## DESCRIPTION

The GV6-150 series is constant voltage led driver, designed for lighting used for landscape illumination. The driver has built-in active PFC, multiple protections, and 10KV surge immunity. It's an excellent design with high reliability and long lifetime.

## MODEL INFORMATION

MODEL NUMBER	OUTPUT POWER [W]	OUTPUT VOLTAGE [VDC]	OUTPUT CURRENT RANGE [A]	TYPICAL EFFICIENCY	TYPICAL PF	TYPICAL THD
GV6-150B012	150	12	0 ÷ 12.5	92%	0.97	10%
GV6-150B024	150	24	0 ÷ 6.30	93%	0.97	10%
GV6-150B036	150	36	0 ÷ 4.17	93%	0.97	10%

### Notes:

1. All performance parameters are measured at 25°C ambient temperature, 230VAC input, full load conditions if no specific note.

## INPUT SPECIFICATIONS

Parameter	Min.	Typ.	Max.	Notes					
INPUT VOLTAGE	176VAC	200 ÷ 240VAC	264VAC	-					
INPUT FREQUENCY	47Hz	50/60Hz	63Hz	-					
LEAKAGE CURRENT	-	-	0.7mA	240VAC/60Hz					
INPUT AC CURRENT	-	-	1A	220-240VAC, full load					
INRUSH CURRENT	-	-	75A	230VAC, full load, Cold start					
POWER FACTOR	0.96	-	-	230VAC, 50-60Hz, full load					
	0.95	-	-	230VAC, 50-60Hz, 75% load					
	0.90	-	-	230VAC, 50-60Hz, 50% load					
THD	-	5% (for GV6-150B024, GV6-150B036)	10%	220-240VAC, 50-60Hz, 50-100% load					
MAX. NO. OF PSU ON CIRCUIT BREAKER	B10	C10	B16	C16	B20	C20	B25	C25	230VAC
	5	8	7	12	9	15	11	18	

# GV6-150 series

150W Waterproof Constant Voltage LED Driver



## OUTPUT SPECIFICATIONS

Parameter	Min.	Typ.	Max.	Notes
OUTPUT VOLTAGE TOLERANCE	-5%	-	+5%	-
TOTAL OUTPUT CURRENT RIPPLE (PK-PK)	-3%	-	+3%	Full load, measured by 20MHz bandwidth oscilloscope and the output paralleled a 0.1μF ceramic capacitor and 47μF electrolytic capacitor
TURN-ON VOLTAGE OVERSHOOT	-5%	-	+5%	220-240VAC, full load
LINE REGULATION	-0.5%	-	+0.5%	25°C ± 10°C ambient temperature, input voltage changes from 200VAC to 240VAC
LOAD REGULATION	-1%	-	+1%	25°C ± 10°C ambient temperature, 230 VAC input, load changes from 50% to 100%
TURN-ON DELAY TIME	-	-	0.5s	230VAC, full load

## GENERAL SPECIFICATIONS

Parameter	Min.	Typ.	Max.	Notes
<b>EFFICIENCY AT 230VAC</b>				
GV6-150B012	91% / 88% / 85%	92%	-	25°C ambient temperature, full load / 75% load / 50% load
GV6-150B024	91% / 88% / 85%	93%	-	
GV6-150B036	91% / 88% / 85%	93%	-	
<b>DIELECTRIC STRENGTH</b>	<b>INPUT-OUTPUT</b>	-	3750VAC	Max 5mA/60s
	<b>INPUT-PE</b>	-	1875VAC	
	<b>OUTPUT-PE</b>	-	500VAC	
<b>GROUNDING RESISTANCE</b>	-	-	0.1Ω	25A/60s, 25°C ± 10°C ambient temperature
<b>INSULATION RESISTANCE</b>	10MΩ	-	-	Input-Output, Input-PE, Output-PE, 500VDC/60s/25°C/70%RH
<b>MTBF</b>	-	200 000 hours	-	25°C ± 10°C ambient temperature, 230VAC, 80% load (MIL-HDBK-217F)
<b>LIFETIME</b>	-	50 000 hours	-	230VAC, 100% load, tc=75°C (refer to Lifetime Curve)
<b>OPERATING CASE TEMPERATURE FOR SAFETY</b> T <sub>C-S</sub>	-40°C	-	+90°C	-
<b>OPERATING CASE TEMPERATURE FOR SAFETY</b> T <sub>C-W</sub>	-40°C	-	+75°C	5 years warranty, humidity 10% to 100% RH
<b>STORAGE TEMPERATURE</b>	-40°C	-	+90°C	Humidity 10% to 100% RH
<b>DIMENSIONS (L x W x H)</b>	162.5 x 67.2 x 37mm			-
<b>NET WEIGHT</b>	750 ± 50g			-
<b>PACKAGE (L x W x H)</b>	15pcs./box; 500 x 310 x 160 mm			-

# GV6-150 series

150W Waterproof Constant Voltage LED Driver



## SAFETY STANDARDS

SAFETY CATEGORY	COUNTRY / TERRITORY	STANDARDS
CE	Europe	EN61347-1
		EN61347-2-13

## EMC STANDARDS

EMC CATEGORY	COUNTRY / TERRITORY	STANDARDS
CE	Europe	EN55015
		EN61000-3-2
		EN61000-3-3
		EN61547

**Note:** This LED driver meets the EMC specifications above, but EMC performance of luminaire that contains it depends also on the other devices connected to the driver and on the fixture itself.

## PROTECTIONS

PARAMETER	Min.	Typ.	Max.	NOTES
INPUT UNDER VOLTAGE PROTECTION	156VAC	-	176VAC	Turn off the output when the input voltage falls below protection voltage.
OVER TEMPERATURE PROTECTION	Turn off the output. Returning to normal after over temperature is removed.			
SHORT CIRCUIT PROTECTION	Hiccup mode. The output shall return to normal when the fault condition is removed.			
OVER CURRENT PROTECTION	Hiccup mode. The output shall return to normal when the fault condition is removed.			
OVER VOLTAGE PROTECTION	Turn off the output voltage, when the fault is removed, restart and resume.			

# GV6-150 series

150W Waterproof Constant Voltage LED Driver



## MECHANICAL SPECIFICATION

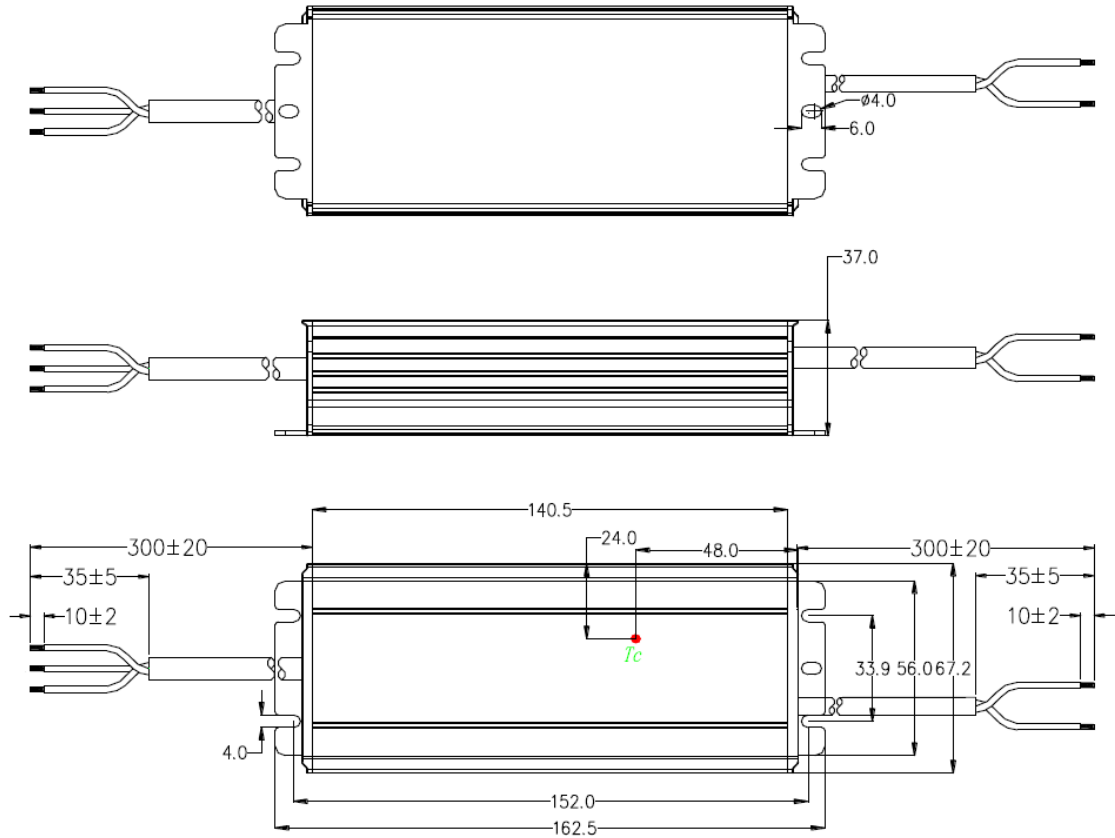

Wire	Specification	Note
INPUT	CCC + VDE, 3x1.0mm <sup>2</sup> , length = 300 ± 20mm, peel-length = 35 ± 5mm, Tin-Dip length = 10 ± 2mm	For CCC/CE
	AC/L: brown, AC/N: blue, FG: green/yellow	
OUTPUT	12V: CCC + VDE, 2x1.5mm <sup>2</sup> , length = 300 ± 20mm, peel-length = 35 ± 5mm, Tin-Dip length = 10 ± 24mm	For CCC/CE
	24V and 36V : CCC + VDE, 2x1.0mm <sup>2</sup> , length = 300 ± 20mm, peel-length = 35 ± 5mm, Tin-Dip length = 10 ± 24mm	
	V <sub>o+</sub> : brown, V <sub>o-</sub> : blue	

## CHARACTERISTICS

### INRUSH CURRENT WAVEFORM

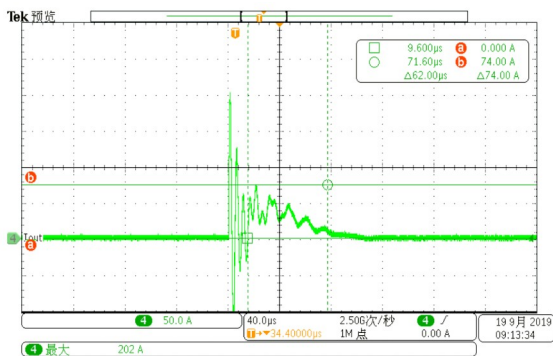

### OUTPUT POWER vs. INPUT VOLTAGE CURVE

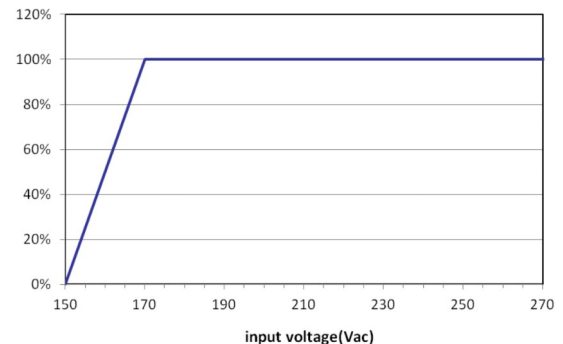

# GV6-150 series

150W Waterproof Constant Voltage LED Driver



## LIFETIME vs. CASE TEMPERATURE CURVE

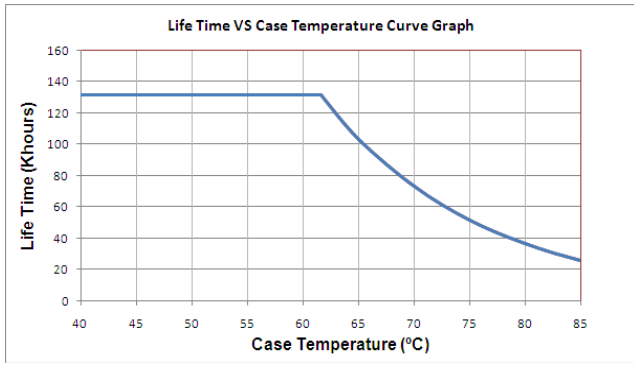

## DERATING CURVE

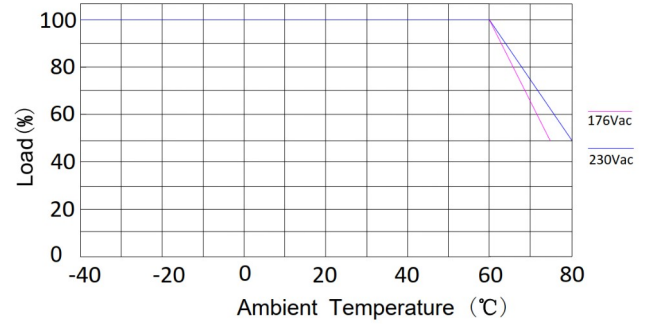

## POWER FACTOR vs. LOAD CURVE

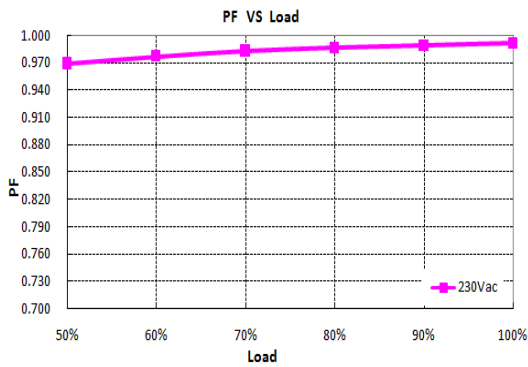

## THD vs. LOAD CURVE

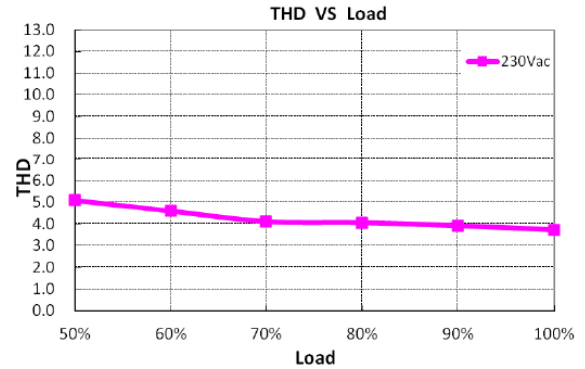

## EFFICIENCY vs. LOAD CURVE

### GV6-150B012

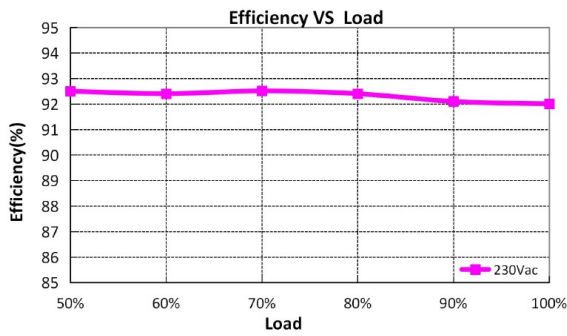

### GV6-150B024

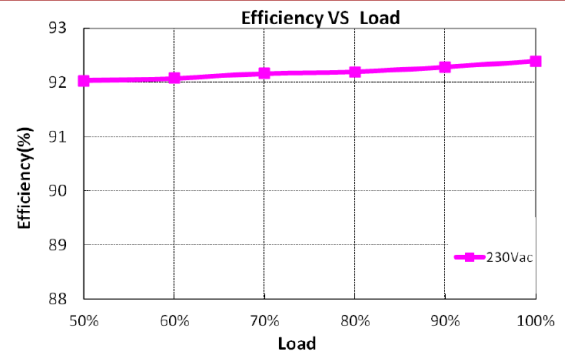

### GV6-150B036

