

Datasheet & Operating instructions

Model: SS5-10C700-D3

LED power supply for 700 mA constant current
7...15 Vdc, 5...10 W, IP65, Built-in installation
TRIAC (trailing edge) dimmable

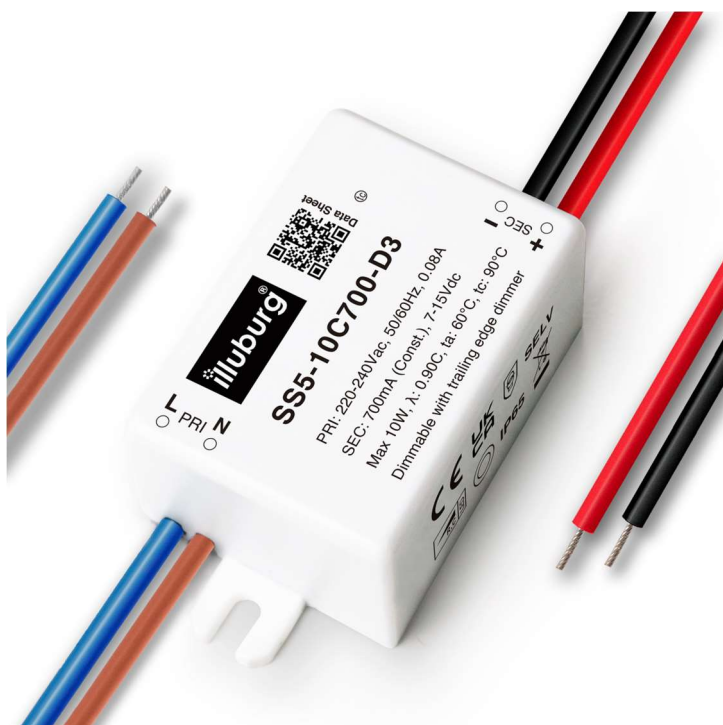

Safety Instructions

- Be sure to switch off the mains voltage before assembly and disassembly.
- Please keep this product away from children and pets.
- Do not place this product under any mechanical stress.
- Handle this product with care. Jolts, impact or falling from even a low height could damage this product and jeopardize its safe operation.
- If this product is visibly damaged / no longer works properly / has been stored for extended periods in poor ambient conditions, please take the product out of service and protect it from any unintentional/accidental use.
- Compare the technical data of all products used, these must be compatible to each other and be within the specified range. Also observe the safety and operating instructions of any other devices which are connected to this product.
- Make sure that the total power of the connected LED lighting does not exceed the maximum output power of the product (see electrical data).
- Only operate the product within the specified ambient temperature (t_a) range (see operating condition).
- Only operate the product in an environment that corresponds to its IP protection class and protect the product from extreme temperatures, direct sunlight, strong shocks, flammable gases, vapors & solvents.
- Never immerse the product in water or other liquids.
- Consult an expert if you have any doubts about the operation, safety or connection of the product.
- Only have maintenance, adjustment and repair work carried out by an expert or at a qualified workshop.
- If you have questions which remain unanswered by these operating instructions, contact our technical support service or other technical personnel.

Read the operating instructions carefully and especially observe the safety information. If you do not follow the safety instructions and information on proper handling in this manual, we assume no liability for any resulting personal injury or damage to property. Such cases will invalidate the warranty/guarantee

Intended use

The LED power supply is a power supply device specially designed for LED lighting. For safety and approval purposes (CE), you must not rebuild and/or modify this product. If you use this product for purposes other than those described above, the product may be damaged. In addition, improper use can cause hazards such as short circuits, fire, electric shock, etc. Read the following notes and the datasheet carefully and completely, they are part of the product and contain important information. Please keep this document and only pass the product on to third parties together with this document.

This product complies with statutory national and European requirements. All company names and product names contained are trademarks of their respective owners.

All rights reserved.

Disposal



Electronic devices are recyclable waste and must not be disposed of in the household waste. At the end of its service life, dispose of the product according to the relevant statutory regulations. You thus fulfil your statutory obligations and contribute to the protection of the environment.



Electrical data

Rated Input Voltage	220...240 Vac	
Range of input voltage	198...264 Vac	
Mains frequency	50/60 Hz	
Power factor (λ)	0.90C	Full Load
Input current	0.08 A	
Inrush current	5 A (t _{th} = 100 μ s)	Cold start
Output voltage	7...15 Vdc	
Output current	700 mA	
Output power (nominal)	5...10 W	
Efficiency	75 %	Full Load
Life time	50,000 h	
Dimmable mode	TRIAC (trailing edge)	
Dimming range	1...100 %	

Operating condition

Operating temperature range (t_a)	-20...+60 °C
Max. Surface temperature (t_c)	90 °C
Permitted rel. humidity	5...85 %
Protection class	II
Type of protection	IP65

Protection

Short circuit protection	Yes *	
Overload protection	Yes *	
No load protection	Yes *	
Overvoltage protection	Yes *	Input: 264 Vac max. Output: \leq 48V
Overheating protection	Yes *	

(*) The output shuts off and will be resumed, after problem is removed and led driver is restarted.

Standards

Standards	EN 61347-1, EN 61347-2-13 EN 62384, EN 60598-1, EN 57710 EN 55015, EN 61547-, EN 61000-3-2, EN 61000-3-3
Approval marks	CE, UKCA
RoHS compliant	Yes

Installation

Cable length, input side	170(±5) mm	
Cable length, output side	170(±5) mm	
Cable cross-section, input side	2x 20AWG	
Cable cross-section, output side	2x 22AWG	
Cable preparation length, input side	5 mm	
Cable preparation length, output side	5 mm	
Circuit breaker (230V)	10A Typ B: 100 pc. 16A Typ B: 160 pc.	10A Typ C: 100 pc. 16A Typ C: 160 pc.

Dimension

AC INPUT (2 x 0.5 MM²)
BROWN (L)
BLUE (N)

DC OUTPUT (2 x 0.5 MM²)
RED (+)
BLACK (-)

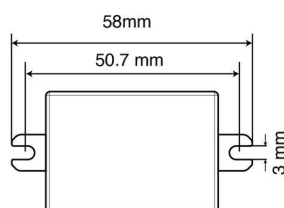
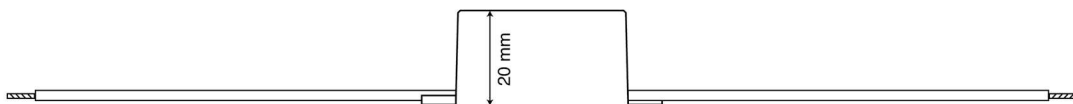
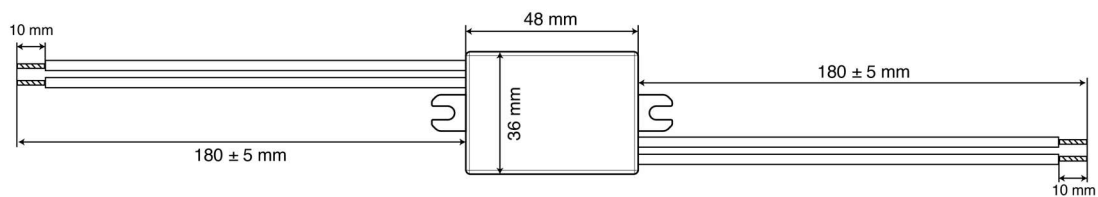

Connection

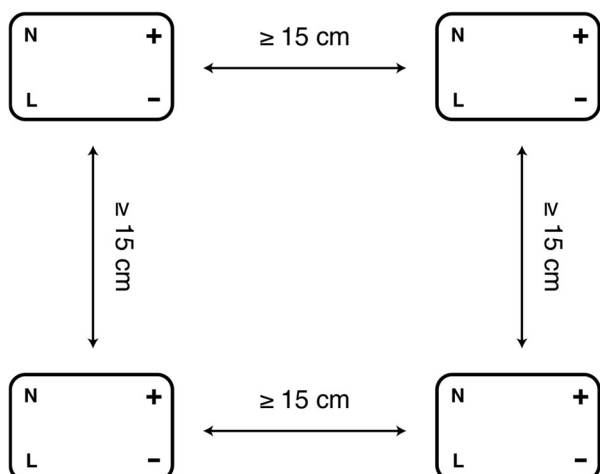
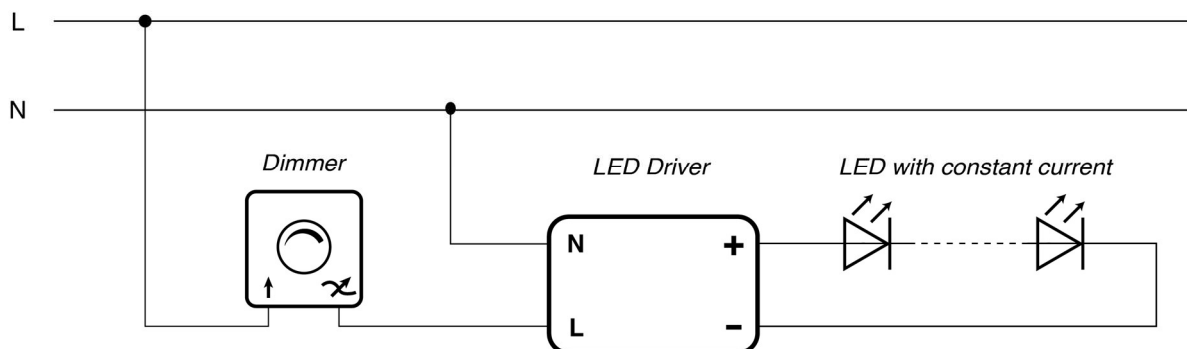

Make sure there is a clearance of at least **15cm** between the LED driver and other heat sources, e.g., other LED power supplies, lamps/LEDs etc.

A distance of at least **5cm** between the LED power supply and other non-heat-producing objects/surfaces is required.



Have the product installed by a qualified expert (e.g., electrician) who is familiar with all applicable regulations! When handling mains voltage improperly, you will not only endanger yourself but also others! If you do not have the relevant expert knowledge, do not install the product yourself, but have it done by an expert.

Installation

- compare all products to be compatible to each other.
- The product must be completely free of voltage for installation.
- Turn off the corresponding circuit breaker and/or automatic fuse to remove all voltage from the power circuit. Secure them against unauthorized restart, e.g., by installing a warning sign. Also switch off the relevant circuit breaker in order to disconnect all poles of the mains cable from the mains supply.
- First, connect your LED lighting to the screw terminals / spring terminals / cables on the secondary side (SEC), ensuring correct polarity. Connect the mains supply line to the corresponding screw terminals / spring terminals / cables on the primary side of the LED driver (PRI). Make sure that all connections are firmly tightened.
- Install the product using the two mounting openings to an even, stable surface.
- Make sure not to damage any cables, wiring or pipes that may run beneath the installation surface when installing the product.
- Finally, make sure the LED driver is correctly connected; do not turn on the power supply until you have verified that the product is installed correctly
- The LED driver is operational as soon as voltage is applied to the primary side.